

Ex-protected hand and machine lamps HL/ML

(Zone 1, 2, 21, 22)

Mains powered and still flexible

These powerful explosion-protected hand lamps with LEDs were developed especially for use during inspection and maintenance work in hazardous areas. Typical applications are found, for example in the chemical industry, offshore, in the automotive sector, in the aircraft industry or in shipyards. Due to their small size and high light output, these rugged lights are especially suited for lighting in tight spaces, the interior of

machinery, silos, etc. wherever a reliable portable light source is required. With the appropriate accessories (optional) the machine lights can also be used, for example, for lighting sampling ports or as tube gauge lights or they can easily be mounted on railing pipes.

Light technology

All hand and machine lamps feature a protective polycarbonate tube with a reflector. They are available in high efficient LED technology. The out-

standing features of the white LED technology are the insensitivity to shock and vibration, as well as the enormous longevity that makes a lamp change over the lifetime of the LED hand lamp superfluous.

Application

Because they are small in size and, at the same time, have a high light output and a high degree of protection IP 68, these rugged lights are particularly suitable for sewage treatment plants where flooding is possible, and wherever a reliable, robust and portable light source is required. The hand and machine lamps are used in engineering, printing machines, in the petrochemical and process industries as well as in the food industry (dusts). They are also suitable for temporary installations where maintenance, alteration and maintenance work are carried out in facilities in the oil and gas industry, for plant construction, in shipyards, or during the

cleaning of tanks. Thanks to the special accessories, the lamps can be mounted by clamps on pipes (railing in the chemical and oil rigs) or with magnets directly to the machine housing or tank walls. At petrol stations, machine lamps can be installed in the illuminated ram protection around fuel pumps. Explosion-protected hand and machine lamps contribute to the operational safety during the construction of airplanes as well as during maintenance work in shipyards work. Here various people are at work in confined spaces in the cargo hold or in the cabin, cleaning parts with solvents, painting or preserving surfaces. During maintenance, the area surrounding the aircraft hull is normally declared as Zone 2, while empty and vented tanks are normally declared as Zone 1.



Features

- With LED-technique from 6 W to 36 W
- Lumen output from 200 lm up to 4780 lm, with directional (180°) or all round lighting (360°)
- Wide voltage range 85 V - 264 V AC/DC for general applications 12 V - 24 V AC/DC for confined spaces (e. g. metal tanks)
- Robust protective tube made of polycarbonate
- Suited for use in explosive gas and dust atmospheres, acc. ATEX & IECEx
- High degree of protection IP68



Safe handling

The hand lamp has a ribbed neoprene rubber handle with a trumpet-shaped cable gland made of metal and a neoprene rubber end cap with attachment hook for hanging up the light in the workplace. The end caps of the machine lamps are also made of durable neoprene rubber. The machine lamps are mounted directly on the machine using suitable clamps. Optionally, all hand and machine lamps can also be fitted with an eXLink connector for the quick and easy disconnection of the power cord at the lamp.

























Ordering details hand lamps

Type	Lamp power	Voltage	Luminous flux	A	Ø B	Ø C	Order No.
HL43d LED6 460	6 W LED	12 - 24 V DC	315 lm	640 mm	66 mm	43 mm	1 1700 000 003
HL43d LED6 460	6 W LED	24 - 50 V AC/DC	315 lm	640 mm	66 mm	43 mm	1 1700 000 004
HL43d LED6 460	6 W LED	85 - 265 V AC; 120 - 370 V DC	315 lm	640 mm	66 mm	43 mm	1 1700 000 107

Ordering details machine lamps

Ordering details ML... LED	Lamp power	Voltage	Luminous flux	A	Ø B/B'	Ø C	Order No.
TL43d LED6 460	6 W LED	12 - 24 V DC	315 lm	581 mm	66 mm	43 mm	1 1700 000 012
TL43d LED6 460	6 W LED	24 - 50 V AC/DC	315 lm	581 mm	66 mm	43 mm	1 1700 000 013
TL60d LED25 1480	25 W LED	24 V AC/DC	2,200 lm	1,601 mm	66 mm	43 mm	1 1700 000 017
TL60d LED25 1480	25 W LED	85 - 265 V AC; 120 - 370 V DC	2,200 lm	1,601 mm	66 mm	43 mm	1 1700 000 520
TL60d LED36 1780	36 W LED	24 V AC/DC	3,200 lm	1,901 mm	66 mm	43 mm	1 1700 000 018
TL60d LED36 1780	36 W LED	85 - 265 V AC; 120 - 370 V DC	3,200 lm	1,901 mm	66 mm	43 mm	1 1700 000 521
LEDM100de36940	2 x 18 W LED	24 - 50 V AC/DC	3,520 lm	985 mm	100 mm	100 mm	1 1700 100 002
LEDM100de36940	2 x 18 W LED	85 - 265 V AC; 120 - 370 V DC	3,520 lm	985 mm	100 mm	100 mm	1 1700 100 009
LEDM100de441245	2 x 22 W LED	24 - 50 V AC/DC	4,310 lm	1,290 mm	100 mm	100 mm	1 1700 100 003
LEDM100de441245	2 x 22 W LED	85 - 265 V AC; 120 - 370 V DC	4,310 lm	1,290 mm	100 mm	100 mm	1 1700 100 010
LEDM100de54940	2 x 18 W LED	24 - 50 V AC/DC	3,840 lm	985 mm	100 mm	100 mm	1 1700 100 001
LEDM100de501550	2 x 25 W LED	24 - 50 V AC/DC	5,100 lm	1,610 mm	100 mm	100 mm	1 1700 100 005
LEDM100de721850	2 x 36 W LED	24 - 50 V AC/DC	7,400 lm	1,895 mm	100 mm	100 mm	1 1700 100 007
LEDM100de54940	3 x 18 W LED	85 - 265 V AC	3,840 lm	985 mm	100 mm	100 mm	1 1700 100 008
LEDM100de501550	2 x 25 W LED	85 - 265 V AC	5,100 lm	1,595 mm	100 mm	100 mm	1 1700 100 012
LEDM100de721850	2 x 36 W LED	85 - 265 V AC	7,400 lm	1,895 mm	100 mm	100 mm	1 1700 100 014

Accessories

Type	Scope of delivery	Height A in mm	Weight kg	Diameter mm	Order unit	Order No.
 Clamp	KFV 3	265	0.26	Ø 40	1	1 1700 000 900
 Clamp	KFV 4	280	0.26	Ø 50	1	1 1700 000 901
 Permanent magnet (adhesion 100 N) ¹⁾	PM 1	130	0.21	Ø 50	1	1 1700 000 911
 Permanent magnet (adhesion 500 N) ¹⁾	PM 2	190	0.68	Ø 40	1	1 1700 000 915
 Permanent magnet (adhesion 500 N) ¹⁾	PM 2	205	0.68	Ø 50	1	1 1700 000 916
 Permanent magnet (adhesion 500 N) ¹⁾	PM 2	215	0.68	Ø 60	1	1 1700 000 918
 Permanent magnet (adhesion 500 N) ¹⁾	PM 2	225	0.68	Ø 70	1	1 1700 000 919
 Permanent magnet (adhesion 500 N) ¹⁾	PM 2	235	0.68	Ø 80	1	1 1700 000 920
 Suspension hook with ball joint	KH 4	183	0.115	Ø 50	1	1 1700 000 921
 Suspension hook with ball joint	KH 6	195	0.120	Ø 60	1	1 1700 000 923
 Suspension hook with ball joint	KH 7	205	0.123	Ø 70	1	1 1700 000 924
 Suspension hook with ball joint	KH 8	215	0.127	Ø 80	1	1 1700 000 925
 Spring clip	FE 3	62	0.02	Ø 40	1	1 1700 000 930
 Spring clip	FE 4	78	0.02	Ø 50	1	1 1700 000 931
 Luminaire key 30-50 mm	SCH 2				1	1 1700 000 940
 Eye bolt with ball joint M5 stainless steel	RS 4	58	0.034		1	1 1700 000 950
 Plastic pipe clamp	CILC 63	115		Ø 63 - 71	1	1 1700 000 960
 Plastic pipe clamp	CILC 71	124		Ø 71 - 80	1	1 1700 000 961
 Plastic pipe clamp	CILC 80	136		Ø 80 - 90	1	1 1700 000 962
 Fixing clip	BS 70		0.012	Ø 70	1	1 1700 000 951

¹⁾ Note: dispatch only by see freight or road freight!

Other accessories/sizes on request

1.5

Dimension Drawing

HL43d LED / TL43/60d LED / LEDM100de / Accessories

HL

1

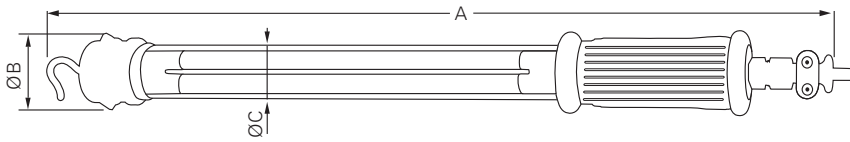

TL

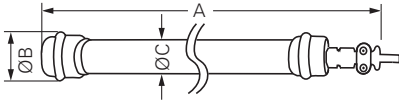

LEDM

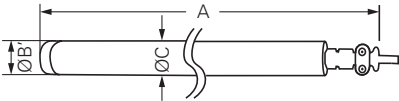

KFV...

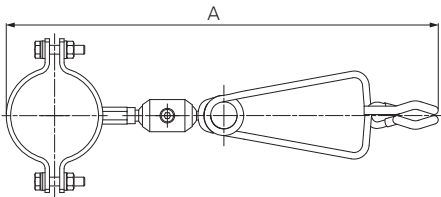

BS 70

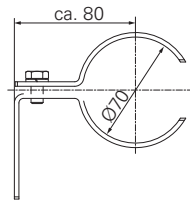

FE...

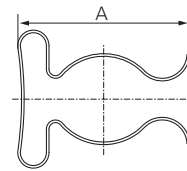

PM 1

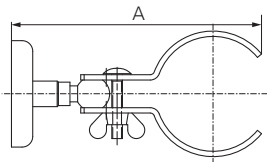

PM 2

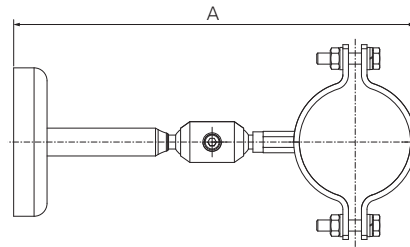

KH...

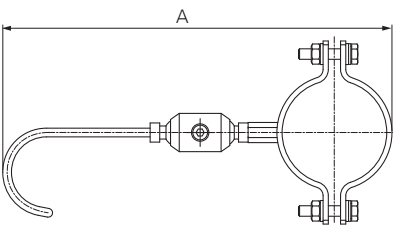

RS4

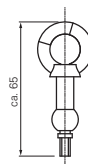

CLIC

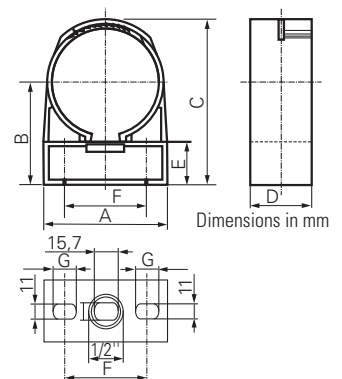

Technical Data / Polar Curve

HL43d LED / TL43/60d LED / LEDM100de

1.5



Technical data

	HL 43 d LED	TL 43/60 LED	ML LED M 100 de...
EC-Type Examination Certificate	BVS 14 ATEX E 106 X	BVS 14 ATEX E 106 X	BVS 15 ATEX E 003 X
IECEx Certificate of Conformity	IECEx BVS 14.0068X	IECEx BVS 14.0068X	IECEx BVS 15.0014X
Marking accd. to 2014/34/EU	⊕ II 2 G Ex d IIC T5 Gb ⊕ II 2 D Ex tb IIIC T95 °C Db	⊕ II 2 G Ex d IIC T5 Gb ⊕ II 2 D Ex tb IIIC T95 °C Db	⊕ II 2 G Ex db e IIB T5 Gb / ⊕ II 2 D Ex tb IIIB T95 °C Db
Marking accd. to IECEx	Ex d IIC T5 Gb Ex t IIIC T95°C Db	Ex d IIC T5 Gb Ex t IIIC IP68 T95°C Db	
Permissible ambient temperature	-20 °C up to +40 °C (PL-lamps) -20 °C up to +60 °C	-20 °C up to +60 °C	-20 °C up to +60 °C
Rated voltage	²⁾	²⁾	²⁾
Power	max. 6 W ²⁾	max. 36 W ²⁾	max. 72 W ²⁾
Power factor cos φ	> 0.95	> 0.95	> 0.95
Circuit	EVG integrated		
Protection class	I bzw. III	I	I
Standard cable length	5 m cable 3 x 1 mm ² without plug ¹⁾		5 m cable 3 x 1.5 mm ² without plug ¹⁾
Lamp / Illuminant	LED ²⁾	LED ²⁾	LED ²⁾
Rated luminous flux	²⁾	²⁾	²⁾
Lamp cap	G5	—	-
Dimensions	²⁾	²⁾	²⁾
Degree of protection accd. to EN 60529	IP68 ³⁾	IP68 ³⁾	IP68 ³⁾
Protection tube	Polycarbonate	Polycarbonate	Polycarbonate

¹⁾ Ex-protected plugs see catalogue 2 part 1 electrical connectivity

²⁾ see ordering details

³⁾ 2.5 m for 24 h

Polar curve HL43d ... LED

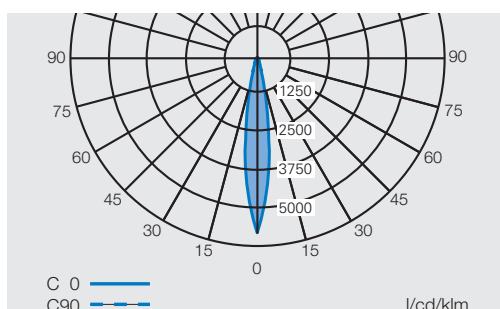

Polar curve TL60d ... LED

