

AT-S+

Components and Options



Controle module

A freely programmable control module with non-volatile program memory and graphic display monitors and controls the test system. All functions such as mains/emergency light switching of the devices and the emergency luminaires are tested automatically. Any faults that occur are signalled immediately. An interface enables a central monitoring facility to be connected.

In the event of a short circuit or open circuit in current loops, differential monitors immediately power on the system (maintained light) or put the system in readiness.

- Non-volatile memory
- Automatic luminaire search function
- Individual luminaire monitoring
- Automatic DLS/TLS search function
- Selective manual reset/circuit
- Selective emergency light/circuit
- Password function
- Final circuit fuse monitoring
- Control module with multi-master mode M³

Displays include:

- Date/Time
- Power source for safety services ready for operation
- Infeed of safety lighting from power source for safety services
- Power source for safety services faulty
- Manual reset
- Test mode
- Delay-time on mains return (remaining time in min.)
- Luminaire failure with location label
- UV-AV failure (location specification)
- Failure/programming information

Connections

- Connection for disable switch:

24V control loops for blocking the installation during factory shutdowns with differential loop monitoring for short-circuit and open circuit detection. Differential monitoring: Short-circuit or open circuit result in readiness for operation of the system.

- Connection for phase monitor:

24V current loop for requesting emergency lighting using differential loop monitoring for the detection of short-circuit and open circuits. Differential monitoring: Short-circuit or open circuit result in immediate power on (maintained light) of the system.

- Connection for zero-potential signal contacts and buzzers:

Connection for zero-potential signal contacts, 24 V 0.5 A:

3 relays with common potential, 1 x switching contact each,
One or several from 11 different messages can be assigned to each zero-potential contact. Freely programmable, DIN VDE specification can be called up at any time as a pre-setting.

2 relays with common potential, 1 x open contact each with fixed assignment.

- Connection for analog inputs:

4 of freely assignable 24 V analog inputs, switch function can be programmed negated and non-negated, e.g. for start / cancel function test, disable / enable system, manual reset, maintained light on / off, power on safety lighting as continuity lighting.

Sealed keypad with 2 keys for:

- Test (mains failure)
- Function test start / cancel (Key DT without function)



3 frei zuordbare Funktionstasten für:

- System disable/enable
- Manual reset
- Cancel function test
- Show fault list
- Maintained light off/on
- Power on complete safety lighting system (continuity lighting)
- Mains failure simulation UV-A (emergency operation)



7 control keys

for user-friendly navigation



LED indicators for:

- Ready
- Electrical Source for Safety Services
- Failure



Graphic display:

128 x 64 pixels, backlit, program adjustable contrast and brightness.

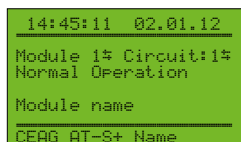

AT-S⁺

Components and Options



Display	128 x 64 pixel graphic display, program adjustable contrast
Illumination	backlighting, program adjustable brightness
Keypad	sealed, with 6 function and 7 control keys
Readout	Infeed of safety lighting from power source for safety services Power source for safety services ready for operation AC isolation fault External fan fault Luminaire failure with location label Manual reset Delay-time on mains return UV-AV failure (location specification) Test mode Date/Time Failure information Programming information
Status	- Ready - Electrical Source for Safety Services - Failure

Potential-free signal contacts, buzzer

3 freely configurable relays with common potential, 1 x switching contact each, 2 relays with fixed assignment and common potential, 1 x open contact each, 24 V 0.5 A; buzzer. Freely programmable, DIN VDE specification can be called up at any time as a pre-setting.

Default setting AT-S ⁺						
Designation	Relay 1 C0/14/12	Relay 2 C0/24/22	Relay 3 C0/34/32	Relay 4 C1/44	Relay 5 C1/54	Buzzer
Ready for operation		X			Permanently configured for control of a technical cabinet ventilation. Default setting >40°C ON < 35°C OFF.	
Mains failure S3/S4	X					
Mains failure DLS/3PH	X					
Ext. source error	X					
Circuit fault	X					
Luminaire fault	X					
Device fault	X					
Ext. source active			X			
ISO error	X					
Function test				X (permanently configured)		
Invert contact		X				

X = active, i.e. contacts C0/14, C0/24, C0/34, C1/44 and C1/54 are closed

Contact assignment:

C0/14: NO C0/24: NO
C0/34: NO C1/44: NO
C0/12: NC C0/22: NC
C0/32: NC C1/54: NO

Note:

NO = normally open
NC = normal closed)

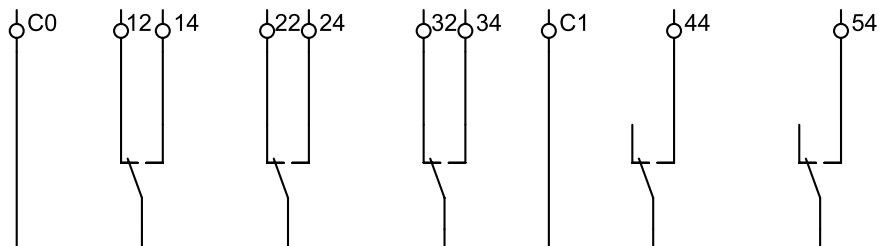

Ordering details

Type	Model	Order No.
Control module CU-S ⁺ with SD	Plug-in module	4 0071 360 371

AT-S⁺ Components and Options



SD card

Secure-Digital-Card

Flexible data storage for system and log book configuration, e.g. of the mandatory archiving of log book information for a minimum of 4 years.

The system can also be programmed at any PC using optional SD-card reader and CEAG software. Texts can also be entered on the control module in the switch cabinet.

Storage of:

- 360,000 log book entries
- Location texts for the luminaires (20 characters per luminaire)
- Location texts of external modules such as phase monitor, DLS, TLS (20 characters per module)
- Circuit names (20 characters per circuit)
- System name (20 characters)



SD card reader

Ordering details

Type	Model	Order No.
SD card	SD card formatted for AT-S ⁺	4 0071 347 911
SD card reader	SD card reader for USB-Port	4 0064 070 561
Software	Software for external programming of the AT-S ⁺ via PC	4 0071 347 152

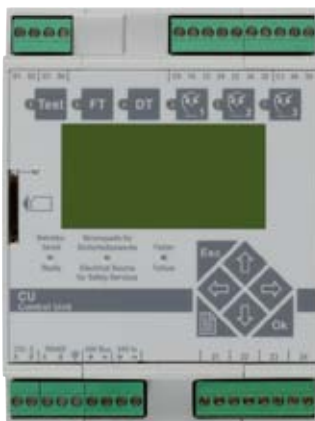

SD-Card (Secure-Digital-Card)

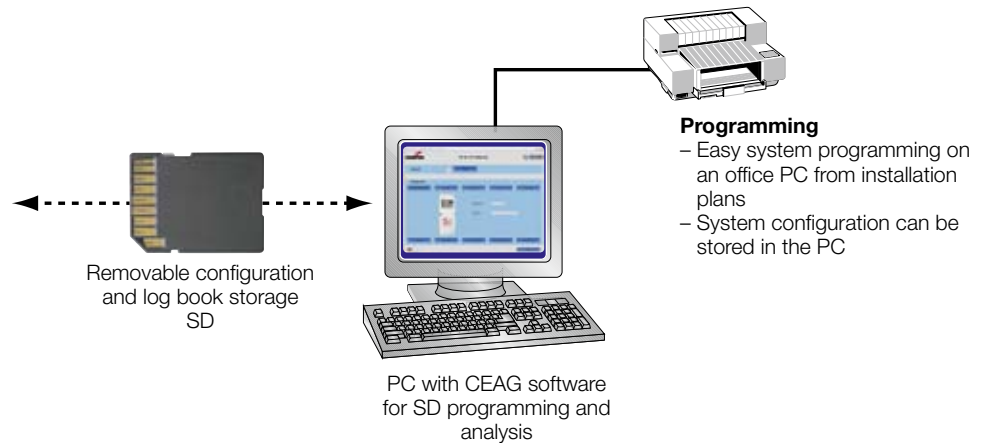

AT-S⁺ Components and Options



DC/DC-Converter.2

DC/DC-Converter.2

The DC/DC converter.2 converts the 240 V AC from the AC supply with galvanic isolation in 24 V DC and 6 V DC for supply of the CU S⁺ control unit.

24 V external	20 W continuous rating Outgoing circuit with front panel connector Isolated voltage
24 V internal	100 W continuous rating 140 W peak rating (20 ms)

Ordering details

Type	Order No.
DC/DC-Wandler.2	7 0071 347 071



AC module

AC module

The AC supply in combination with the DC/DC converter.2 assumes supply of the internal system voltage.

Ordering details

Type	Order No.
AC module	4 0071 346 311

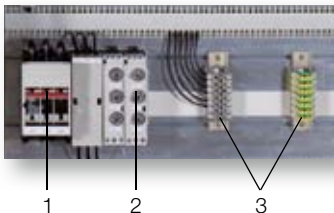

Mains distribution board

Mains distribution board

The mains supply to a AT-S⁺ C30 or AT-S⁺ C16 system comes via a modular mains distribution board. This includes a size 00C load disconnecter (1) with a maximum conductor size of 50 mm² and allows the connection of up to 6 distribution terminals for slave stations to modular size D02-E18 outgoing mains circuits (2) with the necessary terminals for neutral and ground (3). The same mains distribution boards must also be used three-phase for feeders to powerful slave-stations (accommodates up to 2 slave stations in this case). The components are simply plugged on from the front and securely contacted.



Mains distribution module
D02-E18

Current rating	63 A
Rated operating voltage	400 V
Box terminal for circulator conductor	to 16 mm ²
Material	Polyamide (PA 6.6), 30 % glass-fibre-reinforced
Scope of supply	incl. 3 pcs. screw caps E18 and 3 pcs. D02-fuse inserts 25 A

Ordering details

Type	Scope of supply	Order No.
Mains distribution module for track mounting	incl. 3 pcs. screw caps E18 and 3 pcs. D02-fuse inserts 25 A	4 0071 347 160

AT-S⁺ Components and Options



SU S⁺ 2 x 6 A

Switching unit SU S⁺ 2 x 6 A

Hybrid operation of maintained light, non-maintained light and switched maintained light per module can be programmed with no additional data cable.

- Up to 20 luminaires can be monitored individually
- Easy access to fuses
- LED indicates fault and Run/ON for each circuit
- Supplies ballast and LED luminaires
- Service-friendly modular units are wired up and ready to connect to 3-tier 4 mm² disconnect neutral terminals

Fusing	10 AT/250 V, 5 x 20
Continuous current rating	6 A per circuit
Max. inrush current	250 A/ms per circuit
Switching time	450 ms
Own consumption	10.5 W (max.)
Module width	6 subunits (H x W x D = 107 x 90 x 58 mm)

Ordering details

Type	Scope of supply	Order No.
SU S ⁺ 2 x 6 A	Switching unit SU S ⁺ 2 x 6 A	4 0071 360 350
Spare part	Fuse 10 AT (5 x 20) 250 V (PU 10 pcs.)	4 0071 360 483



SOU S⁺ 2 x 4 A

Switching over unit SOU S⁺ 2 x 4 A

Hybrid operation of maintained light, non-maintained light and switched maintained light in a single circuit can be programmed with no additional data cable.

- Up to 20 luminaires can be monitored individually
- Separate AV-feed for rental current
- Easy access to fuses
- LED indicates fault and Run/ON for each circuit
- Supplies ballast and LED luminaires
- Service-friendly modular units are wired up and ready to connect to 3-tier 4 mm² disconnect neutral terminals inside the distribution board

Fusing	8 AT/250 V, 6.3 x 32
Continuous current rating	4 A per circuit
Max. inrush current	250 A/ms per circuit
Switching time	450 ms
Own consumption	9 W (max.)
Module width	10 subunits (H x W x D = 178 x 108 x 60 mm)

Ordering details

Type	Scope of supply	Order No.
SOU S ⁺ 2 x 4 A	Switching over unit SOU S ⁺ 2 x 4 A	4 0071 360 461
Spare part	Fuse 8 AT (6.3 x 32) 250 V (PU 10 pcs.)	4 0071 360 484

AT-S+

Components and Options



Connection terminals

Standard terminals up to 4 mm², rigid or flexible, are provided for connecting the external phase monitors, monitoring equipment and control units. Optional terminals up to 4 mm² on DIN rail for rigid or flexible cables are provided for connecting the final circuits. The terminals are designed as 3-level neutral disconnect terminals.



Three-phase monitoring

Three-phase monitoring

The 3-phase monitoring is for monitoring of general lighting distributors. When one phase fails, the module switches a relay contact and interrupts the standard electronic 24 V current loop. The emergency luminaires in non-maintained mode are switched to mains operation.

Dimensions mm (H x W x D)	85 x 52.5 x 65
Enclosure	Plastic, red
Connection terminals	2.5 mm ² rigid and flexible
Type of mounting	DIN mounting rail
Contact	0.5 A/24 V AC/DC, 1 x open contact, 1 x changeover contact
Trigger threshold	$U < 85 \% U_N$

Ordering details

Type	Scope of supply	Order No.
Three-phase monitoring	Module ready for mounting	4 0071 343 430

Current loop

24 V current loop for emergency lighting request using differential loop monitoring for short-circuit and open circuit detection.

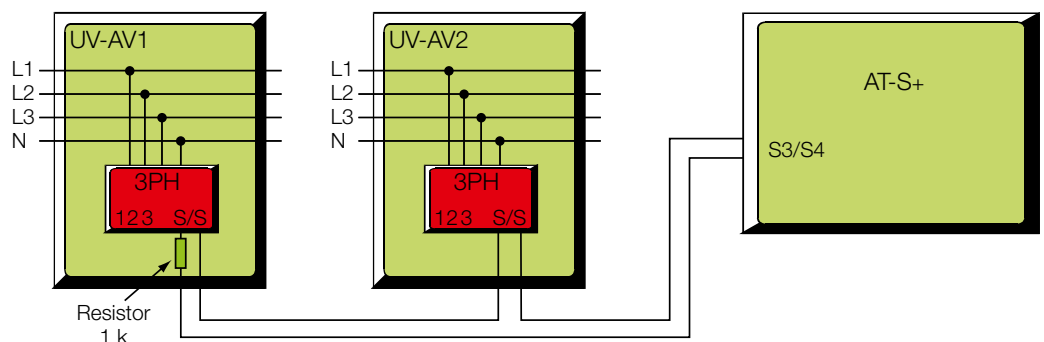

Differential monitoring: A short or open circuit causes the system to energise immediately (maintained light).

Phase monitor switch closed (1 k Ω): Normal system mode

AT-S⁺ Components and Options



F3 remote indication



F3 remote indication for flush-mounting

F3 remote indication

The F3 remote indication ensures display of the most important installation functions. Blocking of emergency lighting operation is possible via a key switch during idle operation times.

Differential loop monitoring leads to operational readiness of the system with short circuits or wire-break detection.

LED displays: system readiness, source for safety services, failure. As such the F3 remote indication fulfills the requirement that remote switching is only permissible when operation by unauthorized persons is not possible.

Connection terminals wall surface-mounting 2.5 mm² rigid and flexible

Dimensions mm (H x W x D) 160 x 80 x 55

Connection terminals for flush-mounting 1.5 mm² rigid or 1 mm² flexible

Dimensions mm (H x W x D) 80 x 80 x 55

Colour enclosure sim. RAL 7035 Light grey

Ordering details

Type	Scope of supply	Order No.
F3 remote indication	Module surface-mounting	4 0071 338 497
F3 remote indication recessed	Performance for installation in the flush-mounted switch or empty space box acc. to DIN VDE 0606	4 0071 347 490

Remote switch

Control loop for blocking the installation during factory shutdowns with differential loop monitoring for short-circuit and open circuit detection.

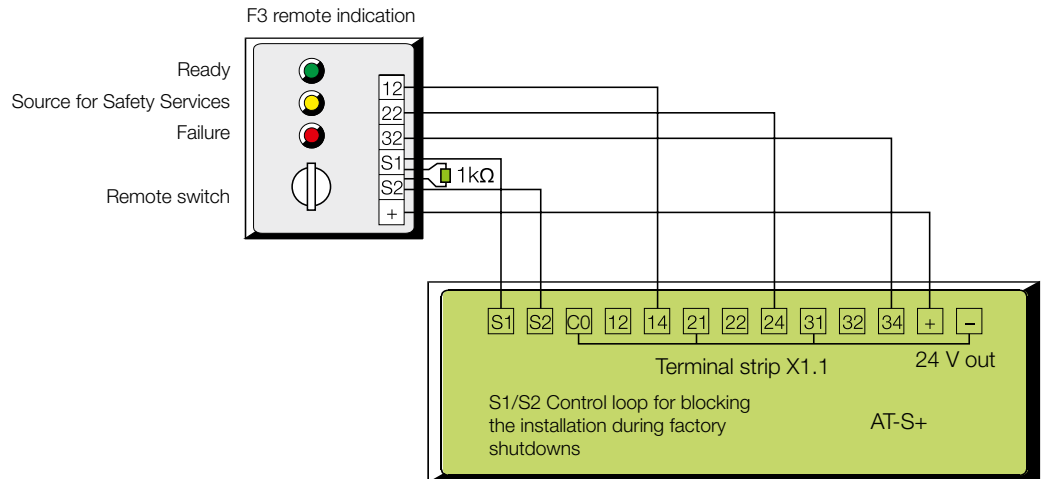

Differential monitoring: A short-circuit or open circuit causes the system to be enabled.

F3 switch closed: System ready

F3 switch open (1 kΩ): System blocked

AT-S⁺

Components and Options



External DLS/3PH-Bus Module

The DLS/3PH bus module can be used as a phase monitor and for light switch polling for the common switching of safety and general lighting systems. Switch cables to the safety luminaires are not required. The housing is suitable for DIN rail mounting. The module has a service button, an RS 485 bus port (integral 120 Ohm bus load resistor) with 24 V module supply, and is addressed with encoding switches. Coloured LEDs indicate fault, ON status and operation. Freely programmable assignment of independent DLS inputs per emergency light circuit or luminaire and individual name per bus module in control unit. With use a 3-phase monitor, detailed phase failure display with location of failed sub-distribution for general lighting via clear text display in control unit.

Supply voltage device	24 V DC (min. 19 V, max. 30 V)
Current consumption (all 8 channel connected)	20 mA ± 5 mA
Degree of protection	IP 20
Insulation class	I
Ambient temperature	- 10 ° to + 40 °C
Input channels 8	U _N = 230 V
DLS (channel 1-8) or	> 195 V -> ON < 138 V -> OFF
DLS (channel 1-5) and 3Ph (channel 6-8)	> 195 V -> ON < 138 V -> OFF
Number of light switch inputs	8 pcs. with LED display or 5 pcs. with 3-phase-monitor (selector)
Monitoring threshold	60 - 85 % U _{Nom} (meets DIN VDE 0100-718)
Data bus	RS 485
Address range	1-25
Weight	0.2 kg
Dimensions (L x W x H) mm	105 x 85 x 60
Mounting	DIN-rail
Connection terminals/Clamp terminals	2.5 mm ² rigid and flexible

Ordering details

Type	Scope of supply	Order No.
DLS/3Ph-Bus-Module	Module for DIN rail mounting	4 0071 346 955
DLS/3Ph-Bus-Module inverse	Module for DIN rail mounting with inverse switching logic	4 0071 347 455
DIN mounting rail	4 pcs. DIN-rails for mounting external modules in the cabinet incl. mounting accessories	4 0071 347 125

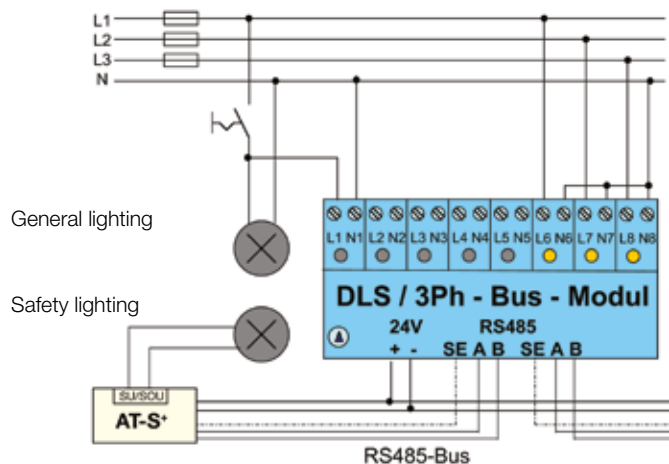

AT-S+

PC-programming software

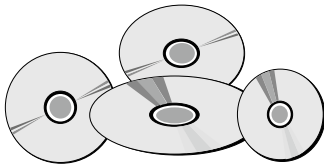

PC-Programmiersoftware AT-S+

Programming software for preset memory cards of the AT-S+ for the quick pre-programming via PC and simple reading and editing of the logbook. For documentation all files are saveable on memory card and hard disk.

Prints for documentation: Detailed prints of the programmed system configuration with the following details:

- individual name of the device
- the date and time of automatic function tests, incl. distance
- manual reset: yes/no
- delay on mains return: 0-15 min
- selective emergency light: yes/no
- Lon switch: yes/no
- assignments of the 5 relays
- assignments of the 3 function keys
- assignments of the 4 option inputs
- number, type and individual name of the bus modules

Detailed print of the programmed electrical circuits (line diagram) with the following details per electrical circuit:

- electrical circuit / module number and type
- individual electrical circuit name
- type of monitoring
- switching mode of the electrical circuit
- number of luminaires
- address and individual name per luminaire
- switching mode of each luminaire

Logbook prints with the following options:

- fault event (35 different fault events, separate or completely generic)
- time period of the logbook (date and time)
- individual comment per print
- luminaire failure: Detail of the individual luminaire and electrical circuit names

Ordering details

Type	Scope of supply	Order No.
Software	PC-Software for AT-S+, for alternative programming of the system configuration on PC	4 0071 610 233

Automatic Test System AT-S⁺ with STAR⁺ Technology



Ordering details

Type	Scope of supply	Order No.
Automatic Test System AT-S ⁺ /C30	Automatic Test System type AT-S ⁺ /C30 incl. CU-S ⁺ , DC/DC.2 and AC module 30 free module slots	4 0071 360 500
Automatic Test System AT-S ⁺ /C16	Automatic Test System type AT-S ⁺ /C16 incl. CU-S ⁺ , DC/DC.2 and AC module 16 free module slots	4 0071 360 501
Automatic Test System AT-S ⁺ /C4	Automatic Test System type AT-S ⁺ /C4 incl. CU-S ⁺ , DC/DC.2 and AC module 4 free module slots	4 0071 360 502
Automatic Test System AT-S ⁺ /C0	Automatic Test System type AT-S ⁺ /C0 incl. CU-S ⁺ , DC/DC.2 und AC module no free module slot	4 0071 360 503
Distribution board AT-S ⁺ /SU4	Distribution board type AT-S ⁺ /SU4 incl. 4 switching units SU S ⁺ 2x6A	4 0071 360 504
Distribution board AT-S ⁺ /SU2	Distribution board type AT-S ⁺ /SU2 incl. 2 switching units SU S ⁺ 2x6A	4 0071 360 505
Distribution board AT-S ⁺ /SU1	Distribution board type AT-S ⁺ /SU1 incl. 1 switching unit SU S ⁺ 2x6A	4 0071 360 506
Distribution board AT-S ⁺ /SOU2	Distribution board type AT-S ⁺ /SOU2 incl. 2 switching over units SOU S ⁺ 2x4A	4 0071 360 508
Distribution board AT-S ⁺ /SOU1	Distribution board type AT-S ⁺ /SOU1 incl. 1 switching over unit SOU S ⁺ 2x4A	4 0071 360 509
Distribution board AT-S ⁺ RV30	Distribution board type AT-S ⁺ RV30	4 0071 360 507

Automatic Test System AT-S+ with STAR+ Technology

AT-S+/C30

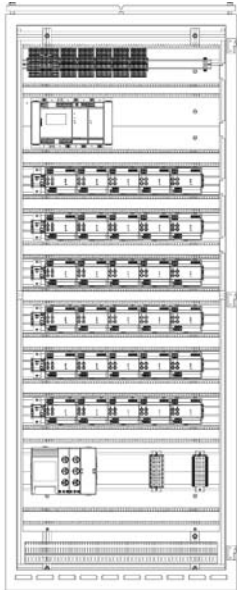

AT-S+/C16

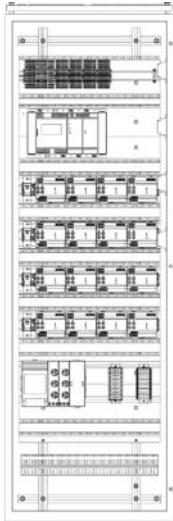

AT-S+/C4

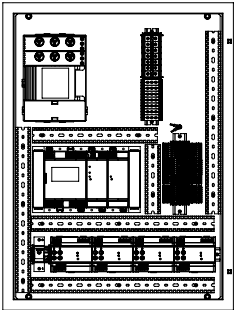

AT-S+/C0

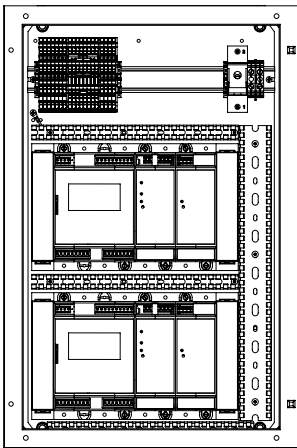

AT-S+/SU4

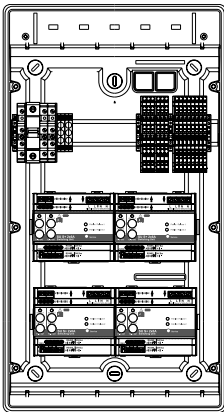

AT-S+/SU2

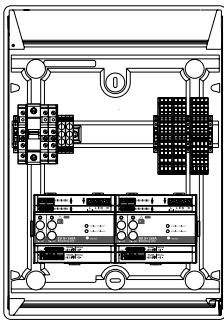

AT-S+/SU1

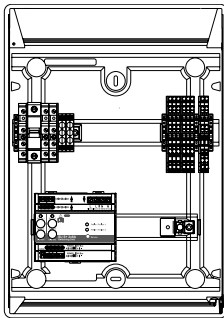

AT-S+/SOU2

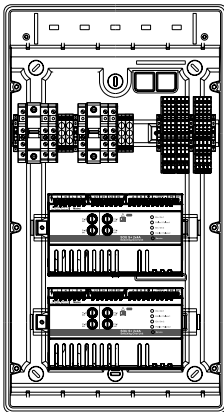

AT-S+/SOU1

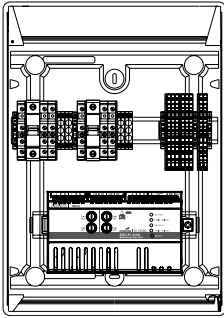

Table of covers

Technical data AT-S⁺

Type	AT-S ⁺ C30	AT-S ⁺ C16	AT-S ⁺ C4	AT-S ⁺ C0	
Modules:					
Control module: CU-S ⁺	1	1	1	1	
DC/DC.2-converter	1	1	1	1	
AC module	1	1	1	1	
Switching unit SU S ⁺ 2 x 6 A	0-30	0-16	0-4	–	
Switching over unit SOU S ⁺ 2 x 4 A	–	–	–	–	
Safety load disconnecter mains feed	yes	yes	yes	–	
Load disconnecter mains feed	–	–	–	yes	
No. of branching distributors	6	6	4	–	
Electrical cabinet construction:					
Rated voltage	400/230 V	400/230 V	400/230 V	230 V	
Rated frequency	50 or 60 Hz	50 or 60 Hz	50 or 60 Hz	50 or 60 Hz	
Netzform AC	TN-C-S	TN-C-S	TN-C-S	TN-C-S	
Insulation class	1	1	1	1	
Degree of protecton	IP 21	IP 21	IP 21	IP 54	
Max. current rating mains [Σ L1, L2, L3] [A]	90	74	48	–	
Max. rated power mains [KVA]	20.7	17	11	–	
Three-phase distribution	yes	yes	yes	no	
Connection cross-section for mains supply	50 mm ²	50 mm ²	50 mm ²	4 mm ²	
Connection cross-section for branching distributors	16 mm ²	16 mm ²	16 mm ²	–	
Max. conductor size final circuits	4 mm ²	4 mm ²	4 mm ²	4 mm ²	
Max. number of final circuit terminals	60	32	8	–	
Mechanical cabinet construction:					
Cabinet height (max.)	2050	1800	1000	600	
Cabinet width (max.)	800	600	600	400	
Cabinet depth (max.)	400	400	300	250	
Material	Sheet steel	Sheet steel	Sheet steel	Sheet steel	
Design	Cabinet	Cabinet	Wall cabinet / surface mounted	Wall cabinet / surface mounted	
Door stop	right	right	right	right	
Outer coating	Textured powder paint	Textured powder paint	Textured powder paint	Textured powder paint	
Colour	RAL 7035	RAL 7035	RAL 7035	RAL 7035	
Partial viewing door	yes	yes	yes	yes	
Lock	3 mm two-way	3 mm two-way	3 mm two-way	3 mm two-way	
Cable entry from above	yes	yes	yes	yes	
Cable entry from below	yes	yes	no	no	
Base (optional)	100/200	100/200	–	–	

*1 = housing has insulation class II. The earth conductor must however be routed in the housing.

Table of covers

Technical data AT-S+

	AT-S+ SU4	AT-S+ SU2	AT-S+ SU1	AT-S+ SOU2	AT-S+ SOU1
	-	-	-	-	-
	-	-	-	-	-
	-	-	-	-	-
	4	2	1	-	-
	-	-	-	2	1
	-	-	-	-	-
	yes	yes	yes	yes	yes
	-	-	-	-	-
	230 V	230 V	230 V	230 V	230 V
	50 or 60 Hz	50 or 60 Hz	50 or 60 Hz	50 or 60 Hz	50 or 60 Hz
	TN-C-S	TN-C-S	TN-C-S	TN-C-S	TN-C-S
	2 ¹	2 ¹	2 ¹	2 ¹	2 ¹
	IP 65	IP 65	IP 65	IP 65	IP 65
	25	16	10	25	10
	5.7	3.7	2.3	5.7	2.3
	no	no	no	no	no
	10 mm ²	10 mm ²	10 mm ²	10 mm ²	10 mm ²
	-	-	-	-	-
	4 mm ²	4 mm ²	4 mm ²	4 mm ²	4 mm ²
	8	4	2	4	2
	583	458	458	583	458
	295	295	295	295	295
	129	129	129	129	129
	Plastic	Plastic	Plastic	Plastic	Plastic
	Wall cabinet / surface mounted	Wall cabinet / surface mounted	Wall cabinet / surface mounted	Wall cabinet / surface mounted	Wall cabinet / surface mounted
	right	right	right	right	right
	-	-	-	-	-
	RAL 7035	RAL 7035	RAL 7035	RAL 7035	RAL 7035
	yes	yes	yes	yes	yes
	on request	on request	on request	on request	on request
	yes	yes	yes	yes	yes
	yes	yes	yes	yes	yes
	-	-	-	-	-